

INFRA·SOLID[®]



Data Sheet HISpower

HIS2000R-A300-6

TO-8 Thermal Infrared Emitter

HIS2000R-A300-6

Thermal infrared emitter with sapphire window, hermetically sealed

Our HIS2000R-A300-6 is a NiCr filament based thermal emitter in a TO8 package, with a gold plated reflector in a hermetically sealed package with a Sapphire window. This guarantees longterm stability. The shorter cap with a height of 6 mm improves the optical signal performance.

HISpower series emitters have an integrated reflector that directs the radiation emitted from the rear to the front through the housing window in order to achieve maximum efficiency. Infracolid's advanced packaging technology allows soldered sapphire, CaF₂ and BaF₂ windows for use in a wide temperature range of -25 °C up to +85 °C.

Key features

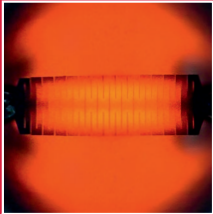

High radiant power

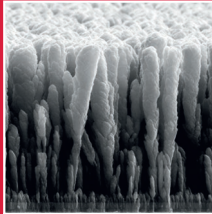

High efficiency



Hermetic housing

- ✓ Pulsable thermal black-body infrared source mounted in an industry standard TO-8 package.
- ✓ Patented nanostructured radiating element achieves up to 500% more detection signal!
- ✓ Lower radiating element temperature of 630 °C increases lifetime!
- ✓ Soldered, high-quality filter windows guarantee considerably less drift. Leakage tested!
- ✓ Wide wavelength range enables a broad range of applications.

innovative infrared sources for gas detection & spectroscopy

Main specifications

Parameter	HIS2000R-A300-6
Package	TO-8
Radiating element area	40 mm ²
Radiating element emissivity	> 0.9
Radiating element temperature	630 °C at 2.5 W
Optical output power	up to 620 mW
Max. electrical power (DC)	2.5 W
Max. electrical voltage	3.8 V
Max. electrical current	660 mA
Electrical resistance	5...6 Ω
Modulation frequency*	4 Hz
Filter/Window	Sapphire (soldered)
Wavelength range	2 to 6 μm
Filling gas	N ₂

* 50 % modulation depth, square wave signal, 50 % duty cycle

Optical specifications

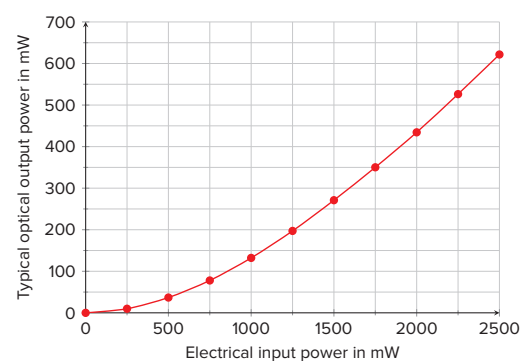
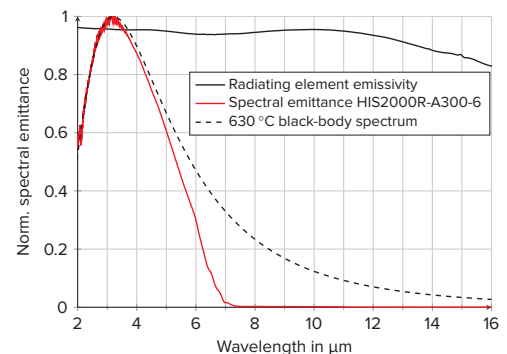

Radiating element temperature

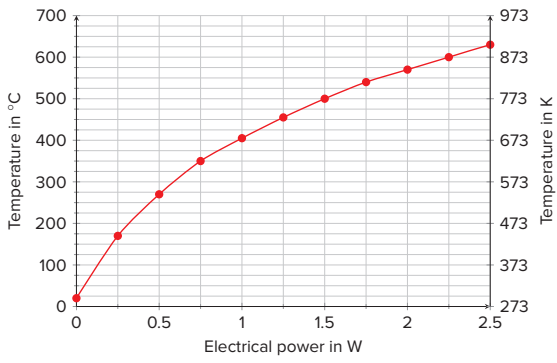

Modulation depth

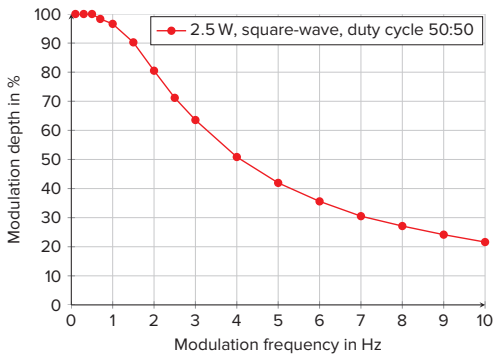

Electrical specifications

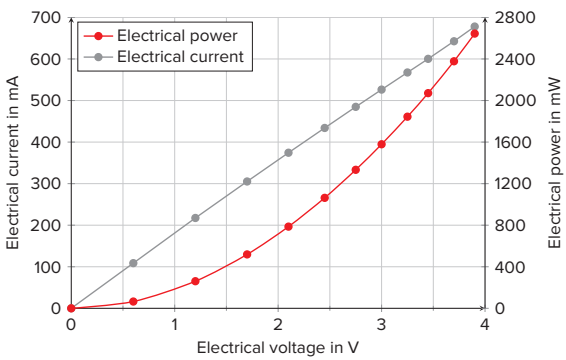

Window material transmissivity

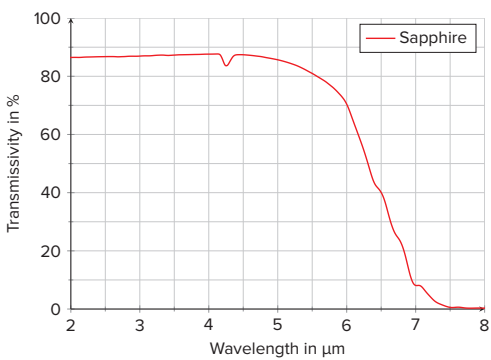

HIS2000R-A300-6

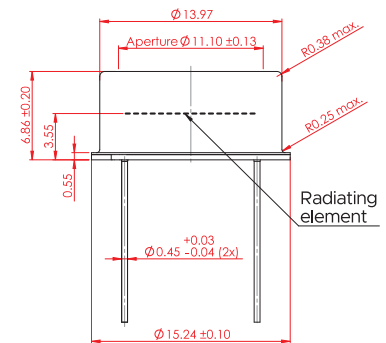
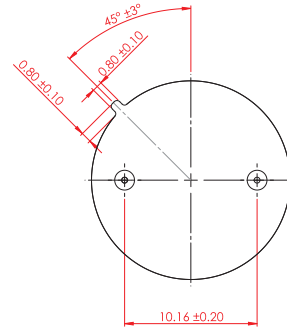

Angular radiation distribution

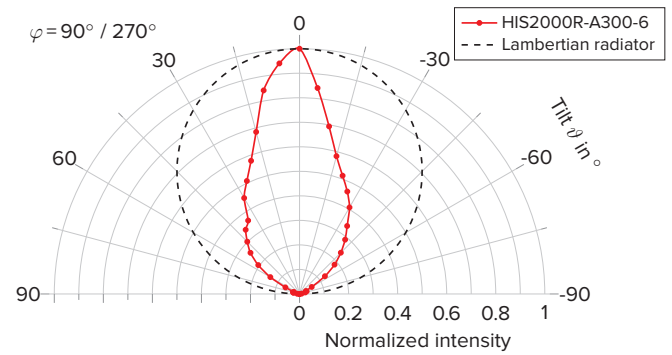
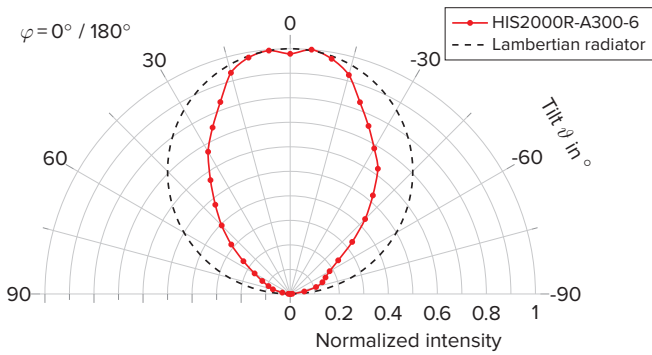
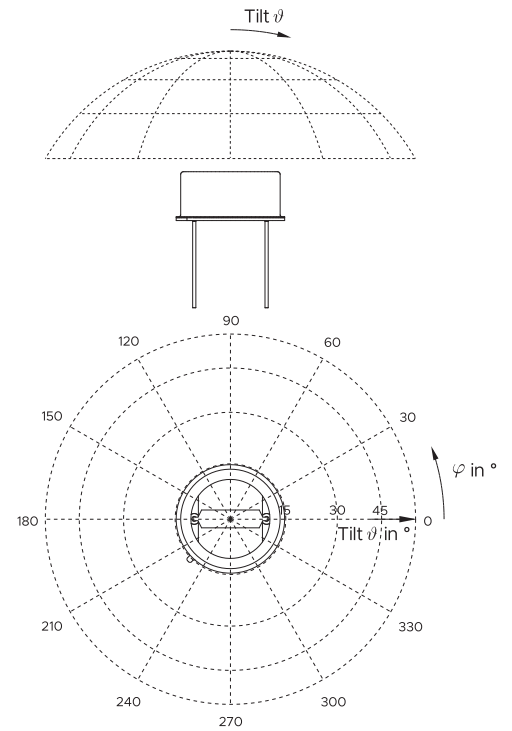
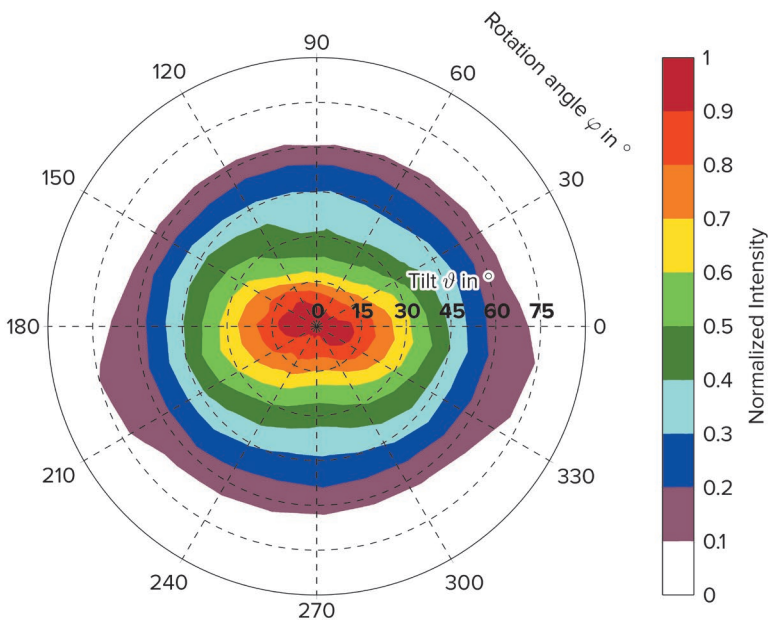

Operating mode recommendation:

All our IR sources can be driven in electrical voltage, current or power regulated mode. The application decides whether the operating mode is DC or AC (pulsed). Depending on the drive mode and the applied electrical power the electrical resistance of the IR emitter can change over time. For highest measurement accuracy a power regulated mode is always recommended for thermal IR emitters. However, it is the most complex operating mode and not suitable in all applications.

For applications that require a small and low-cost driving circuit with a maximum stability we have a technical note with an adjustable low dropout voltage (LDO) regulator.

For further information please refer to:
www.infrasolid.com/technicalnote